

Využití neuronových sítí pro řešení těžkých problémů

Michal Starý, Marek Kadlčík

Neuronové sítě

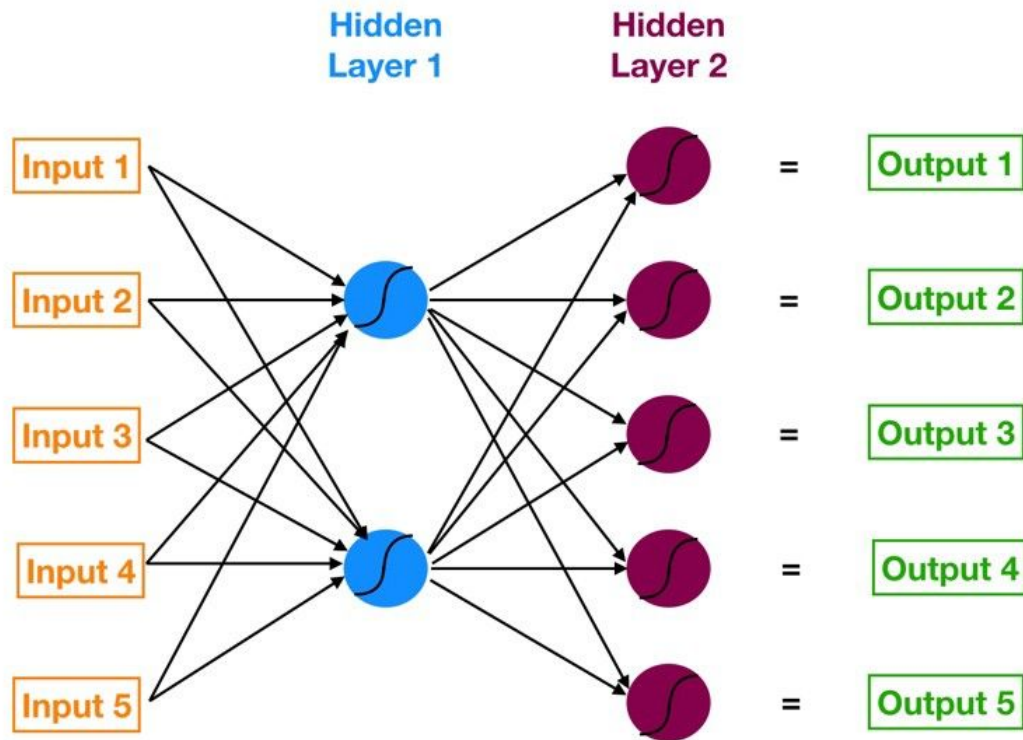

Regrese

Linear

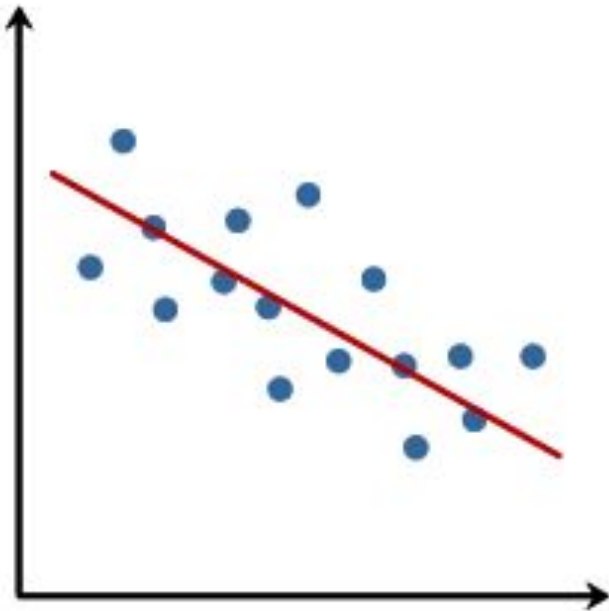

No linear relationship

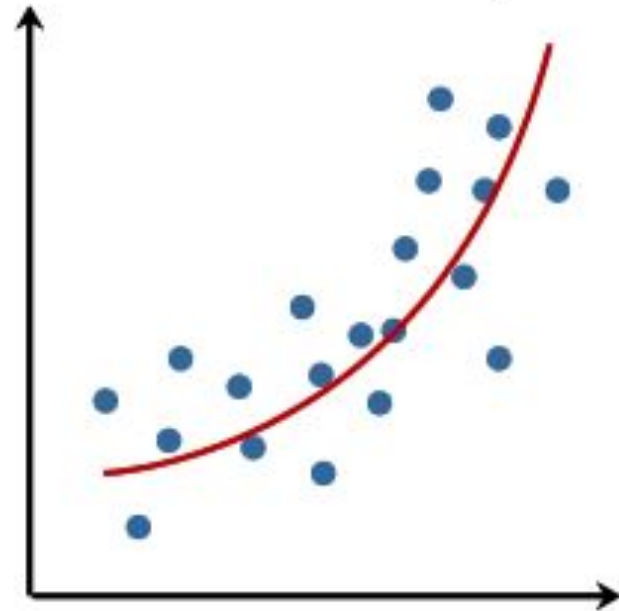

Klasifikace

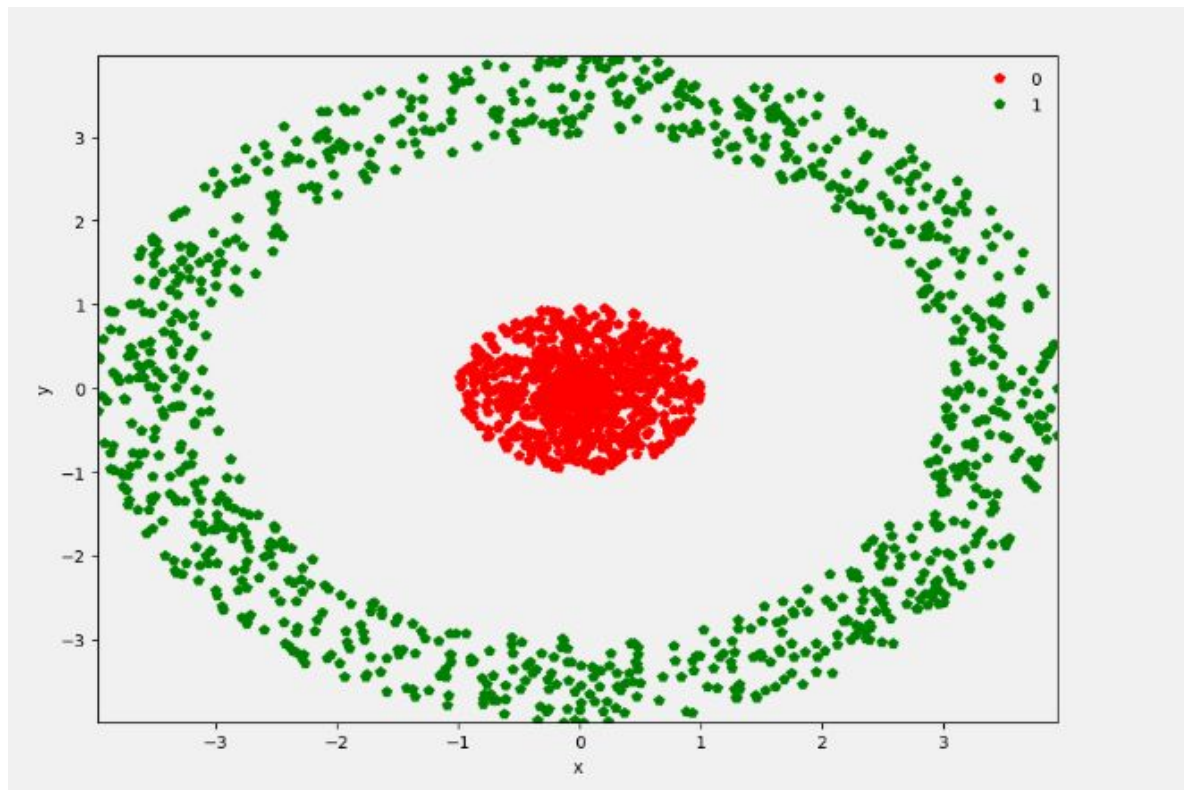

Generace

GPT-2

Konvoluční neuronové sítě (CNN)

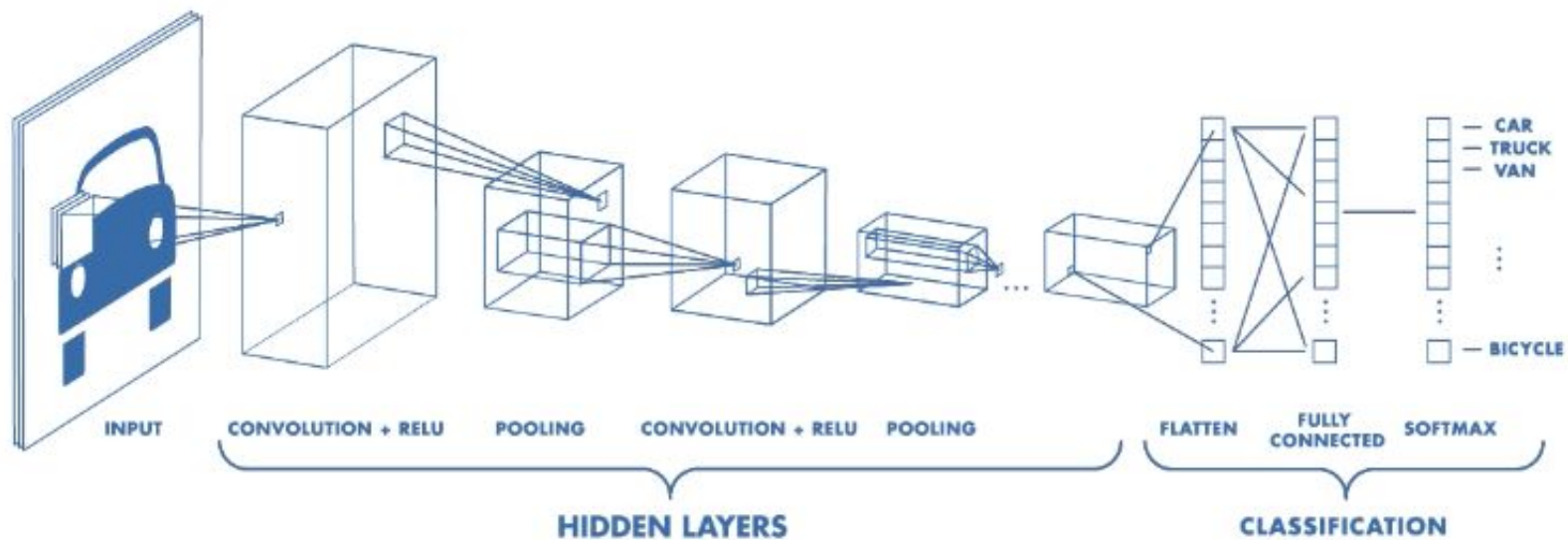

block1_conv1

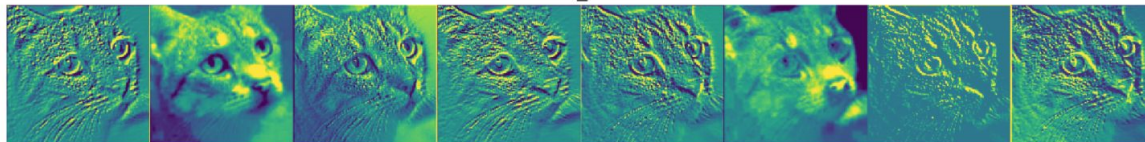

block2_conv1

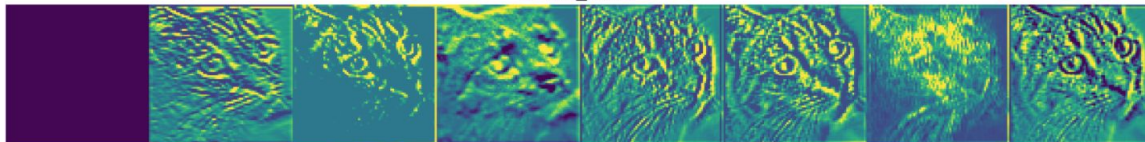

block3_conv1

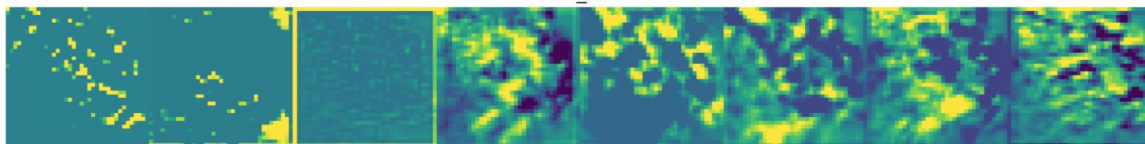

block4_conv1

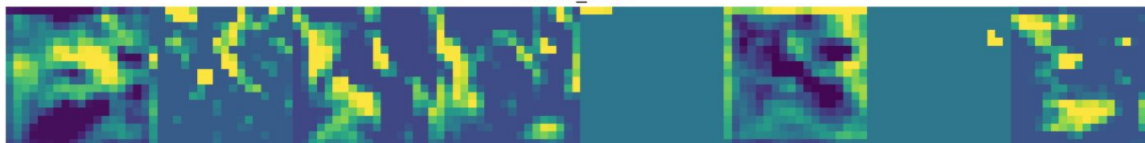

block5_conv1



Detekce objektů z obrázků

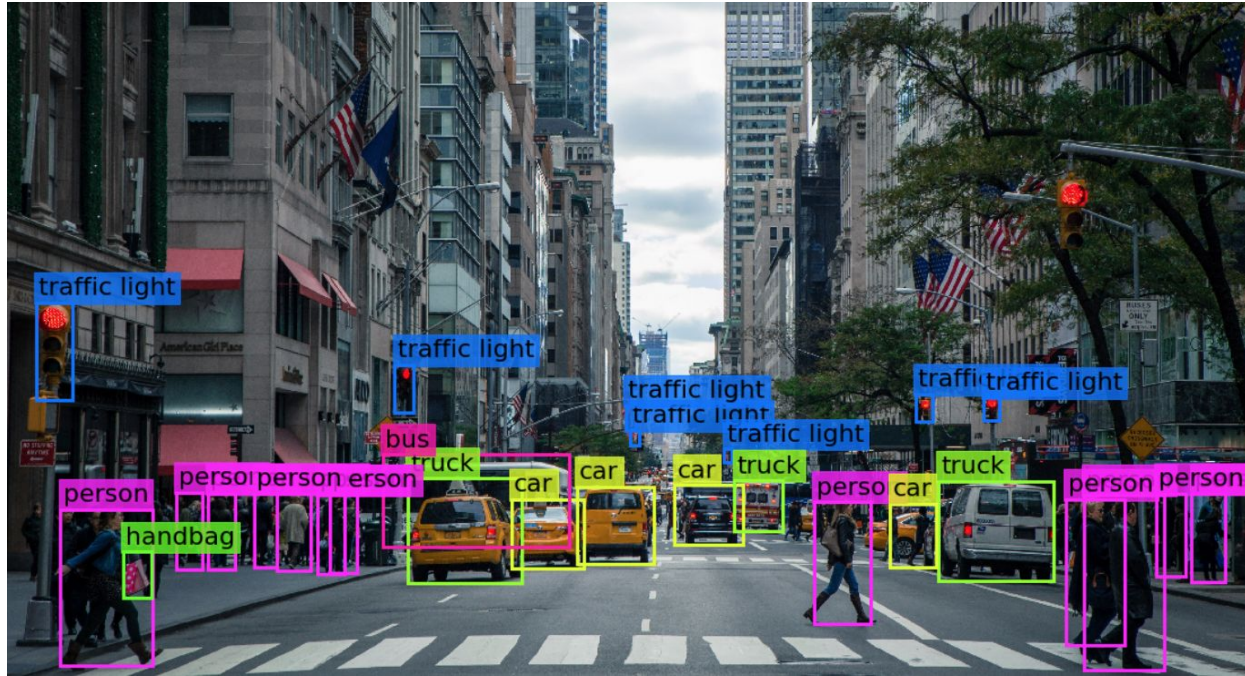

Detekce objektů z obrázků ukázka

Security system on steroids

Long Short Term Memory síť (LSTM)

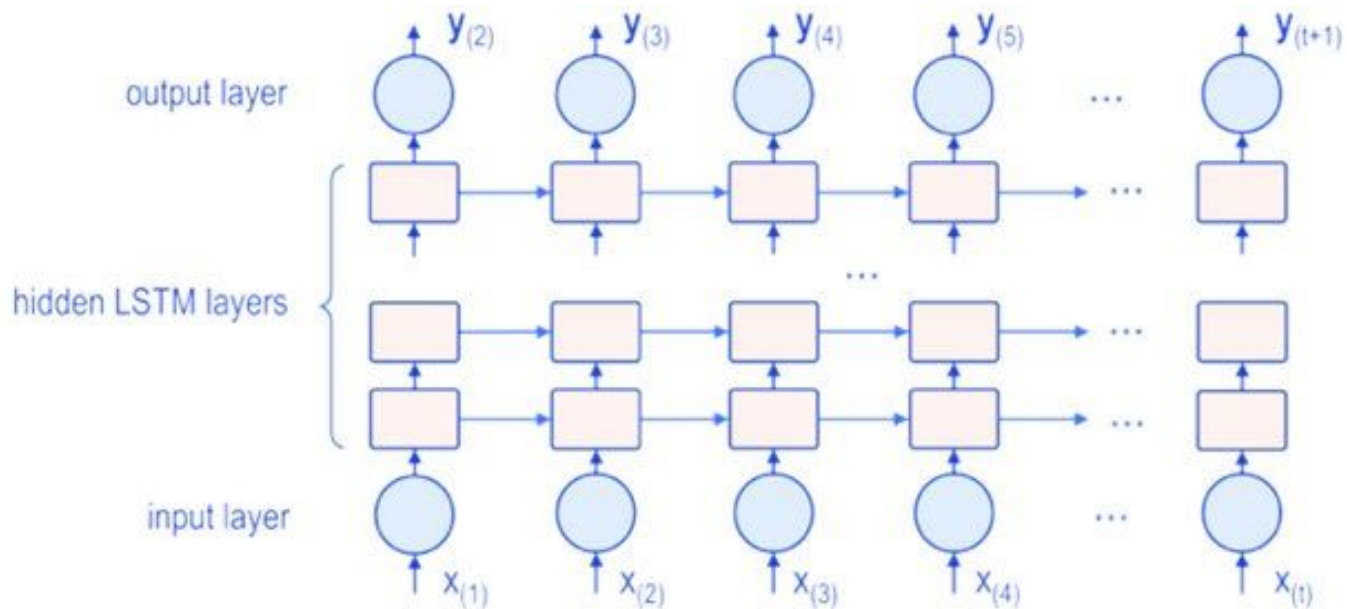

Prediktivní klávesnice

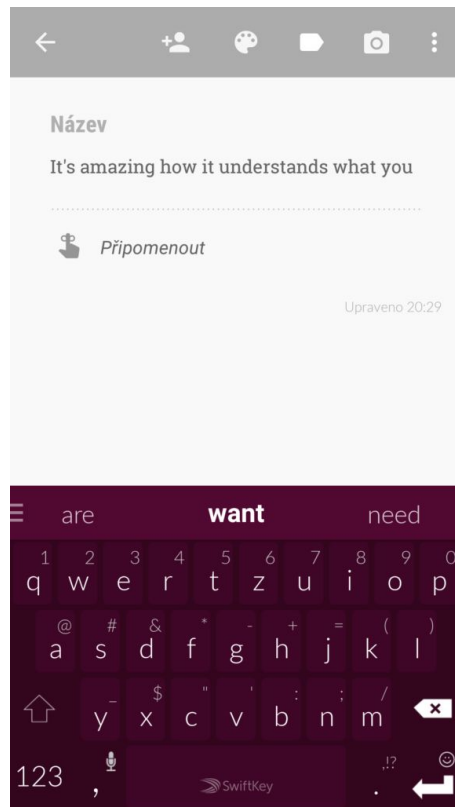

Encoder/Decoder modely

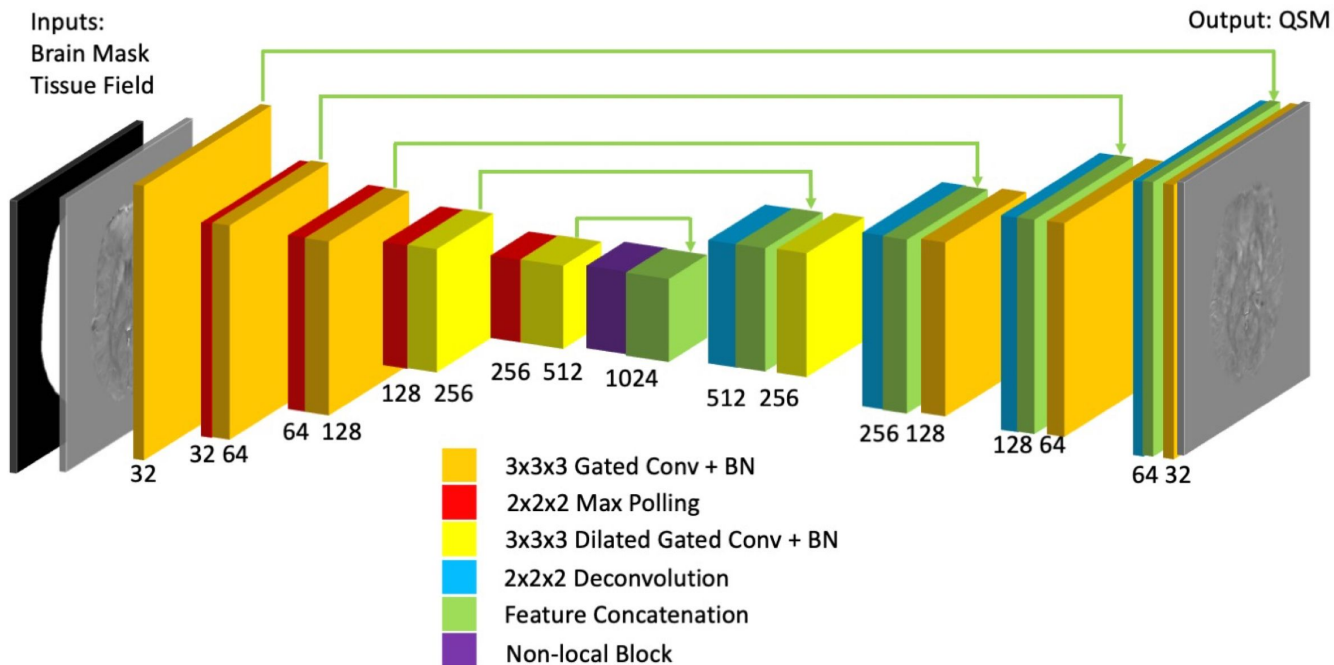

Strojový překlad

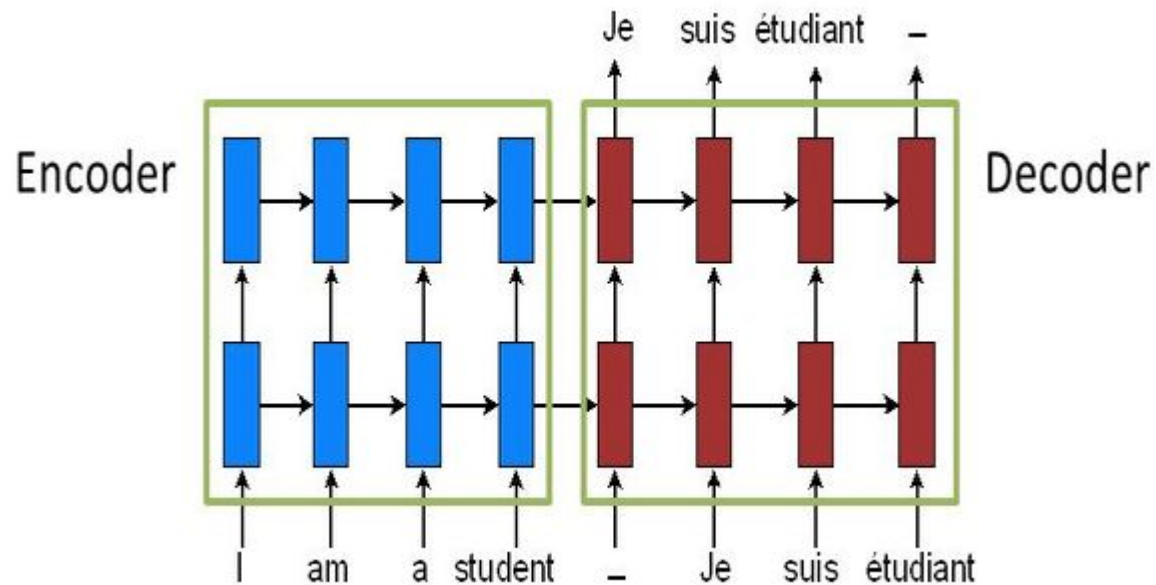

Strojový překlad

Translate

Autoencoders

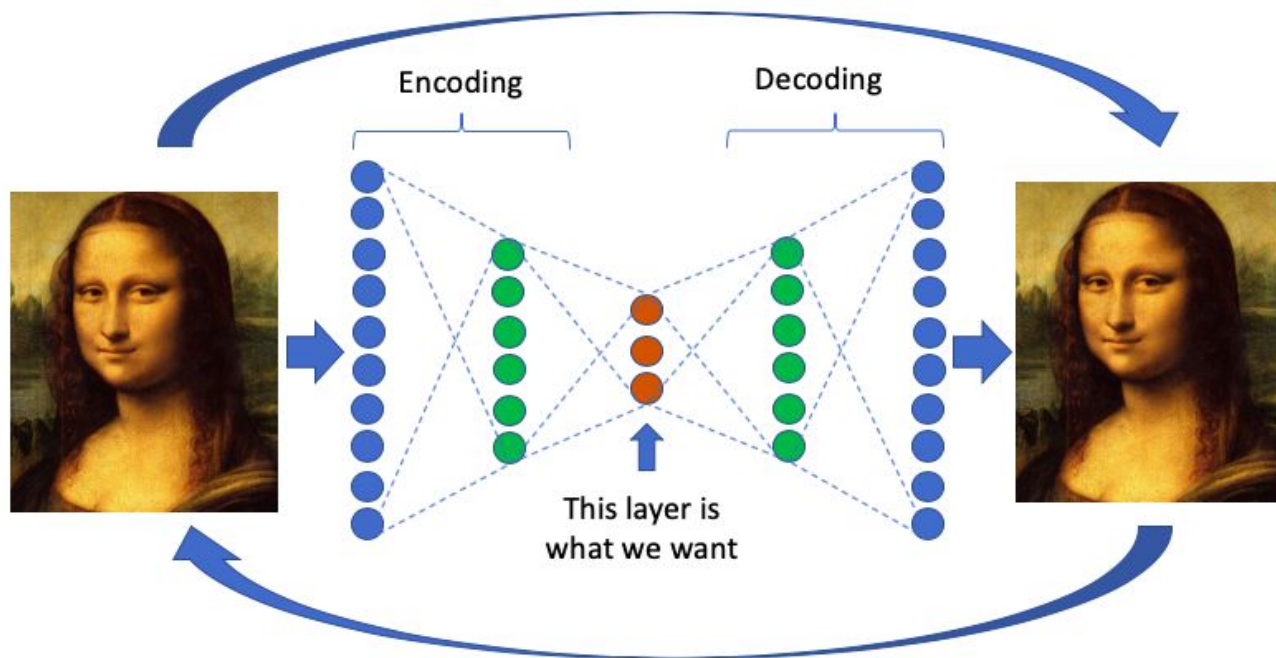

Detekce outlierů

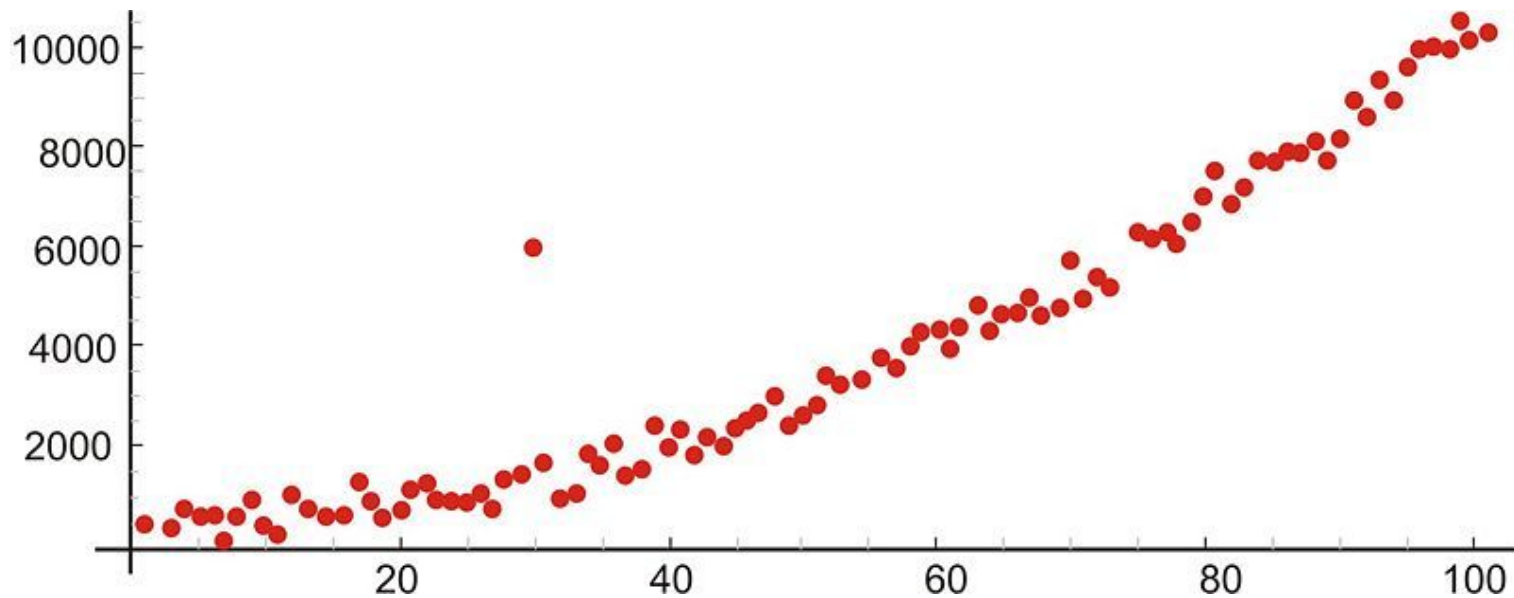

Generative Adversarial Networks (GAN)

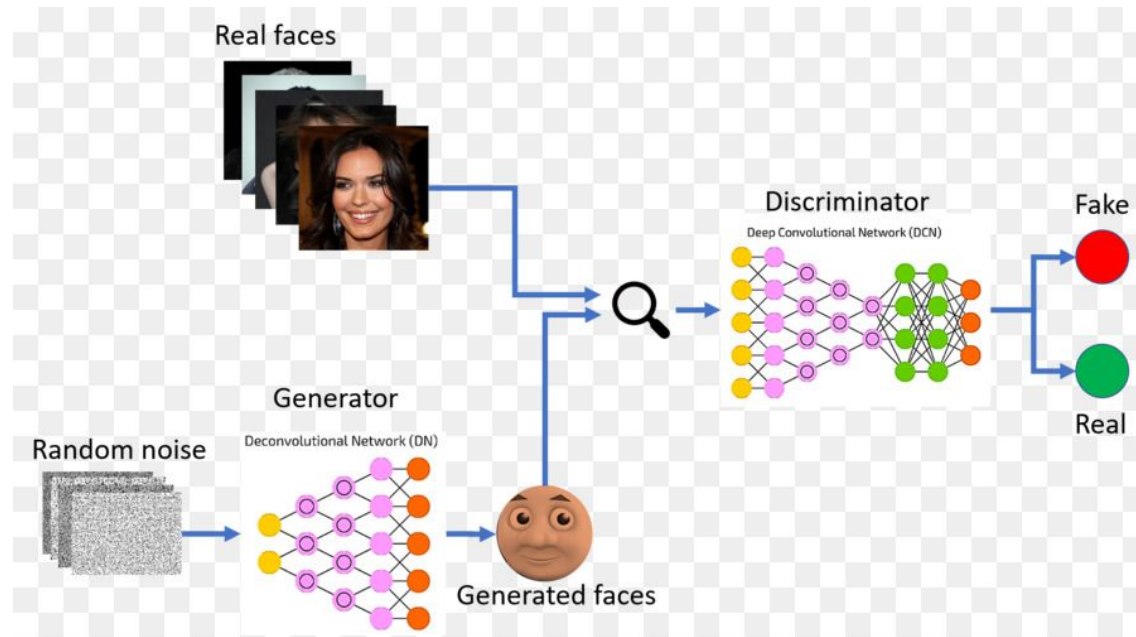

Deepfakes



Neuronové sítě v reinforcement learning

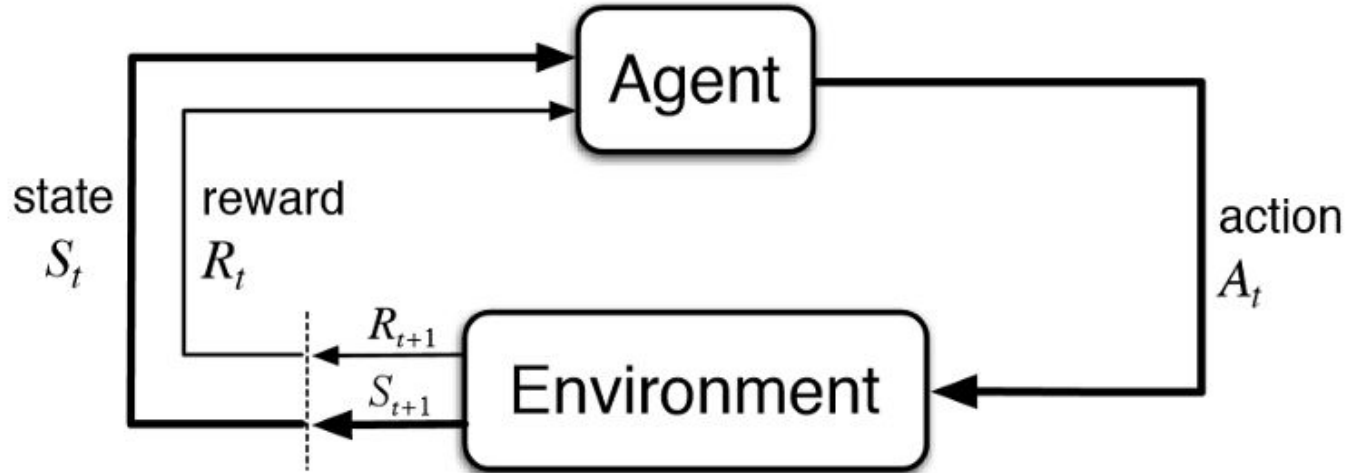

AlphaStar

A screenshot from a StarCraft II match. The top left corner shows a 'PRODUCTION' window with a P2 icon. The top right corner features the 'DeepMind STAR CRAFT DEMONSTRATION' logo. The bottom left corner displays a '7:01 REPLAY' timer and a 'Catalyst LE' icon. The bottom right corner has the 'BILZARD ENTERTAINMENT' logo. The main game area shows a complex Zerg base with numerous units and structures. A player name 'AlphaStar' is visible near a unit. The bottom status bar shows the following data:

Player	Score	Supply	Minerals	Gas	Workers	Army	Weapons & Armor
AlphaStar	2	85 / 102	275 +1287	130 +527	39	46	
LiquidMaNa	0	76 / 84	390 +1579	124 +713	38	38	

Q&A

Zdroje

<https://iq.opengenus.org/types-of-autoencoder/>

<https://blogs.oracle.com/datascience/fraud-detection-using-autoencoders-in-keras-with-a-tensorflow-backend>

[https://www.ck12.org/book/Probability-and-Statistics---Advanced-\(Second-Edition\)/section/9.2/](https://www.ck12.org/book/Probability-and-Statistics---Advanced-(Second-Edition)/section/9.2/)

<https://www.svetandroida.cz/swiftkey-neural-alpha-klavesnice/>

https://subscription.packtpub.com/book/big_data_and_business_intelligence/9781789957211/20/ch20lvl1sec112/deep-learning-for-computer-vision

<https://www.pngfly.com/png-972f1i/>

<https://towardsdatascience.com/anomaly-detection-with-autoencoder-b4cdce4866a6>

<https://github.com/tensorflow/nmt>

<https://medium.com/idealo-tech-blog/zoom-in-enhance-a-deep-learning-based-magnifying-glass-part-2-c021f98ebede>

<https://www.cnews.cz/alphazero/>

<https://www.kdnuggets.com/2018/03/5-things-reinforcement-learning.html>

<https://mashable.com/2018/01/31/nicolas-cage-face-swapping-deepfakes/?europe=true>

<https://towardsdatascience.com/deep-learning-for-named-entity-recognition-2-implementing-the-state-of-the-art-bidirectional-lstm-4603491087f1>

<https://medium.com/dpa-newslab/8-lessons-learned-about-ner-f40b263490db>

https://www.researchgate.net/publication/326038469_Deep_Learning_for_Improved_System_Remaining_Life_Prediction/figures?lo=1

<https://towardsdatascience.com/basics-of-the-classic-cnn-a3dce1225add>

https://github.com/matterport/Mask_RCNN

<https://medium.com/udacity/computer-vision-nanodegree-program-what-youll-learn-668dbfc3e5a3>

<https://is.muni.cz/auth/el/fi/podzim2019/PV021/um/ns.pdf>